

24088, IC BOX FOR TE222

PRODUCT DETAILS

No.	:	24088-015
Length	:	18.25"
Width	:	12.75"
Height	:	11.5"

TECHNICAL DETAILS

Cut Hole Length	:	12.5"
Cut Hole Width	:	6.5"



OPTIONS AVAILABLE

ITEM NO.	FINISH	SHADE
24088-015		

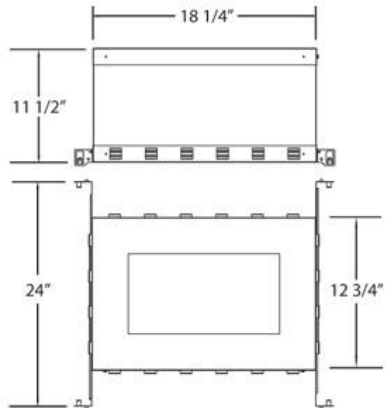

PROJECT INFORMATION

Job Name: Date: Category:

Comments: